

COUTAUD MANUTENTION













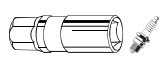























JUNIOR Line

1/4"
3/8"
1/4"
CrV

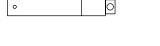
109
PCS

Coffret d'outils universel type alu







très compact, avec outils professionnels pour usage domestique au quotidien



-  8 4-4.5-5-5.5-6-7-8-9 mm
-  11 10-11-12-13-14-15-17-18-19-22-24 mm
-  2 16 mm / 21 mm
-   3/8"  1/4"
-   3/8"  1/4"
-  150 mm
-   3/8"  1/4"
-  Art. 1010
-   4  4 PH 0-1-2-3
-  3 PZ 1-2-3
-  7  7 T10-T15-T20-T25-T27-T30-T40
-  6  1/4"  1/4"
-  8  1/4"  1/4"
-  250 mm / 10"
-  4  9 1.5-2-2.5-3-4-5-6-8-10 mm
-  2 5.0 x 100 mm
6.0 x 100 mm
-  2 PH1 x 75 mm
PH2 x 100 mm
-   110-250V
-  300 g
-  150 mm
-  3 18 mm
-  10 18 mm



365 x 265 x 133 mm



-  180 mm
-  160 mm
-  200 mm
-  250 mm
-  9 LED's
-  3 m x 16 mm

Art.		
1043	1/4" + 3/8"	1/4"

Siège Social
ZA LE PEUBLE, rue Blaise Pascal - 85 470 BRETIGNOLLES SUR MER
Téléphone : 02 51 20 16 16 - FAX : 02 51 90 53 81

Agence
ROCHEFORT : 19 Av. André DULIN - 17300 ROCHEFORT
Téléphone : 05 46 88 04 32 - Fax : 05 46 88 04 51

KRAFTWERKtools.com

e-mail : contact@coutaud-manutention.fr
www.coutaud-manutention.fr

~~178 € HT~~
139 € HT